

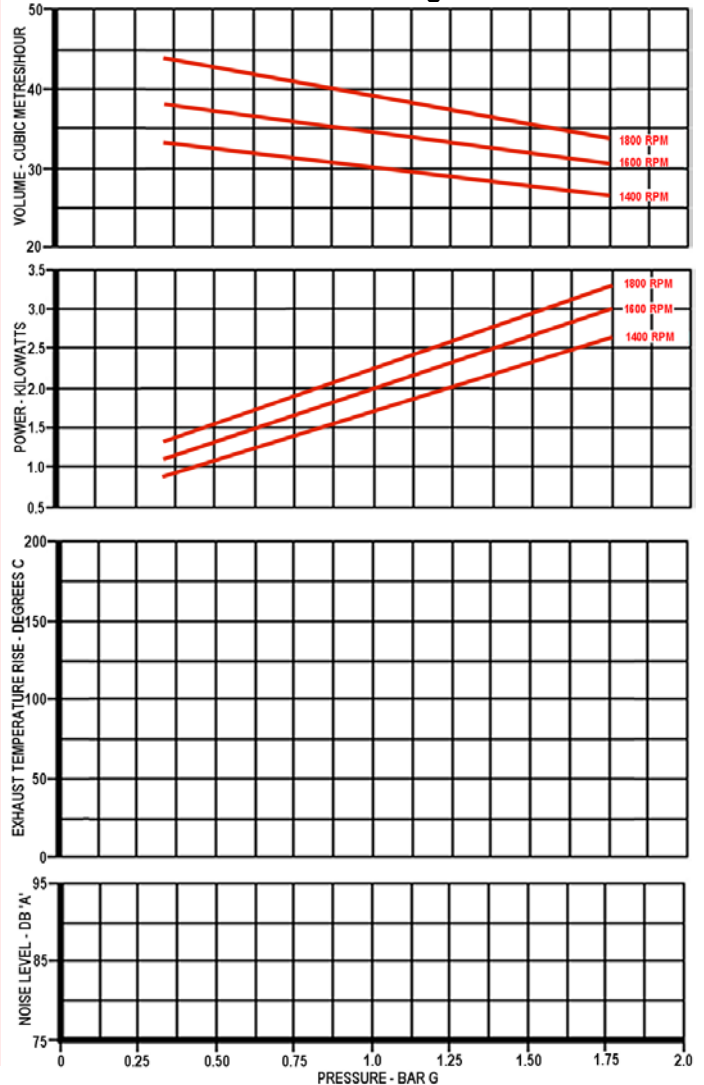

Model LGA26 Lubricated Rotary Sliding Vane Compressor



Air Performance Figures



Materials of Construction

Component	Material Specification
Cylinder	Grey Cast Iron EN-GJL-200 / EN-JL-1030 (EN1561)
Coverplates	Grey Cast Iron EN-GJL-200 / EN-JL-1030 (EN1561)
Rotor / Shaft	S.G. Iron EN-GJS-400-15 / EN-JS-1030 (EN1563)
End Caps	Grey Cast Iron EN-GJL-200 / EN-JL-1030 (EN1561)
Sleeve	Mild Steel 230M07 (BS970-3)
Blades	Non-Asbestos Resin Bonded Fabric
Ball Bearing	Single row deep groove with metal cage. Clearance - Normal
Roller Bearing	Single row, cylindrical roller with metal cage. Clearance - Normal
Mechanical Seal	Viton – O-ring & Bellows, Carbon face
Lip Seals	316 Stainless steel spring Steel cased, Viton

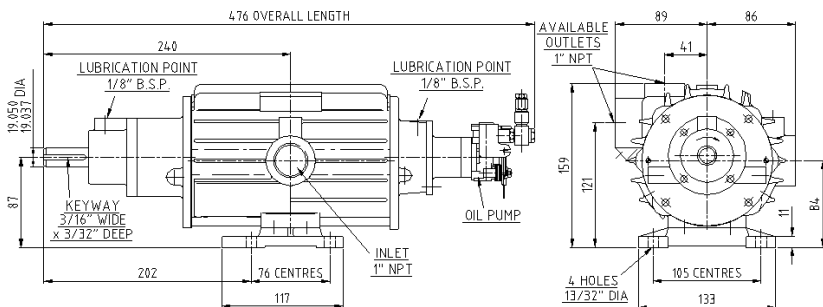

SPEED

Maximum Speed	-	2200	RPM
Minimum Speed	-	1000	RPM

TEMPERATURE

Max. Inlet Temp.	-	40	°C
------------------	---	----	----

INERTIA

Moment Of Inertia	-	0.010	Kgm ²
-------------------	---	-------	------------------

WEIGHT

Approximate Weight	-	21	kgs
--------------------	---	----	-----

LUBRICATION

Bearings and blades lubricated using SHELL RIMULA 15W/40 oil

BEARING ARRANGEMENT

Ball and roller bearing at drive end with roller bearing at rear end giving approximate life values of drive end 62500 hours and rear end 54000 hours.